



S6

Multivoltage 50x50 mm compact sensors series

- 50x50 mm compact dimensions
- Free voltage Vac/Vdc models with relay output
- 10-30 Vdc model with transistor output
- Standard cable or M12 4-pole connection



SENSORS

APPLICATIONS

- Automatic machines
- Packaging lines
- Transportation lines
- Automatic warehouses



S6		
Through beam		0...20 m
Retroreflective (on R2 reflector)		0,1...6 m
Polarized retroreflective (on R2 reflector)		0,1...5 m
Diffuse proximity		10...900 mm
		10...2000 mm
		30...100 mm
Background suppression		30...250 mm
		100...500 mm
Power supply	Vdc	10...30 V
	Vac	
	Vac/dc	15...264 Vac/Vdc
Output	PNP	▪
	NPN	▪
	NPN/PNP	▪
	relay	▪
	other	
Connection	cable	▪
	connector	▪
	pig-tail	
Approximate dimensions (mm)		18x50x50
Housing material		ABS
Mechanical protection		IP65

TECHNICAL DATA	
Power supply	10 ... 30 Vdc limit values (mod. S6/S6T/S6R-5) 15 ... 264 Vac/Vdc (48 ... 60 Hz) limit values (mod. S6-1)
Ripple	2 Vpp max.
Consumption (output current excluded)	30 mA max. (mod. S6/S6T/S6R-5) 40 mA max. (mod. S6-1)
Light emission	IR LED 880 nm red LED 660 nm (mod. S6/S6R/S6T...B/M10)
Setting	sensitivity trimmer (excl. mod. S6...G, S6R-5-M) adjustment screw (mod. S6/S6T/S6R-5-M)
Operating mode	LIGHT/DARK selection by cable or connector (mod. S6/S6T/S6R-5) LIGHT/DARK selection by N.O./N.C. output (mod. S6R-5-M) LIGHT/DARK selection by trimmer (mod. S6-1)
Indicators	red OUTPUT LED (excl. mod. S6...G), POWER LED (mod. S6...G) green STABILITY LED (mod. S6-5-M25)
Output	NPN/PNP (mod. S6) PNP (mod. S6T) NPN or PNP; NC; NO (mod. S6R) Relay 1 NO and NC contact 250 Vac, 30 Vdc min. applicable load 5 Vdc, 10 mA (mod. S6-1)
Output current	100 mA max., 3 A max. (mod. S6-1)
Saturation voltage	1,5 V max. (NPN/PNP output)
Response time	1 ms max. 2 ms max. (mod. S6/S6R/S6T...F/G) 30 ms max. (mod. S6-1)
Switching frequency	500 Hz 250 Hz max. (mod. S6/S6R/S6T...F/G) 16 Hz (mod. S6-1)
Connection	2 m cable Ø 6 mm (mod. S6-1), 2 m cable Ø 5 mm (mod. S6-5), M12 4-pole connector (mod. S6T-S6R)
Dielectric strength	500 Vac, 1 min between electronics and housing
Insulating resistance	>20 MΩ, 500 Vdc between electronics and housing
Electrical protection	class 2, class 1 (mod. S6-1)
Mechanical protection	IP65
Ambient light rejection	according to EN 60947-5-2
Vibrations	0,5 mm amplitude, 10 ... 55 Hz frequency, for every axis (EN60068-2-6)
Shock resistance	11 ms (30 G) 6 shock for every axis (EN60068-2-27)
Housing material	ABS UL 94V-0
Lens material	PMMA plastic
Operating temperature	-25 ... 55 °C
Storage temperature	-25 ... 70 °C
Weight	160 g max. cable vers., 40 g max. conn. vers.

DIMENSIONS

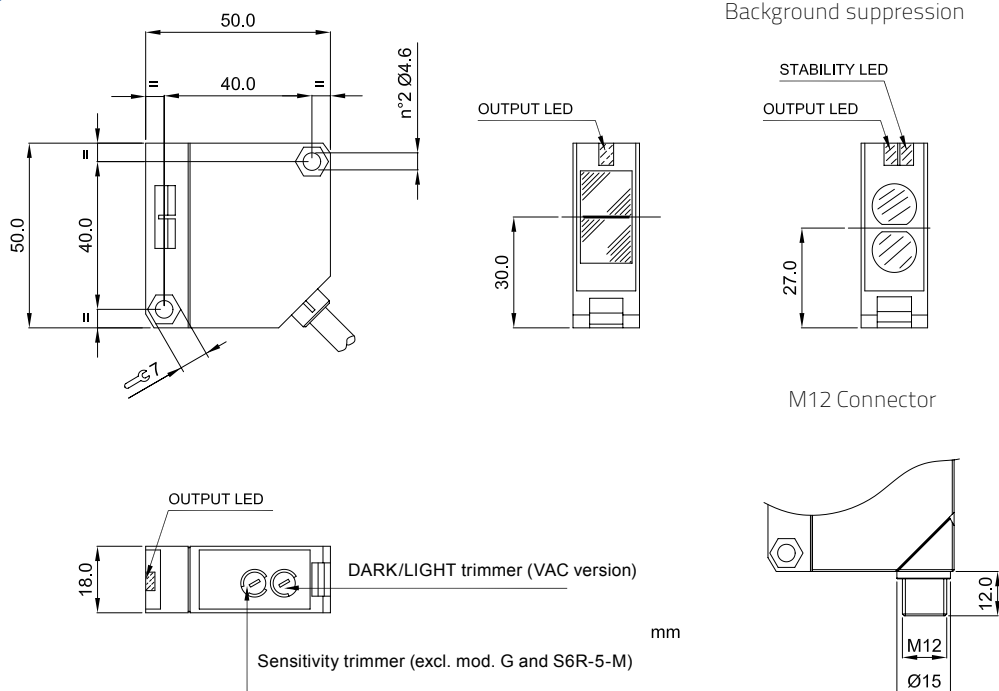

CONNECTIONS

VDC MODELS

NPN/PNP version

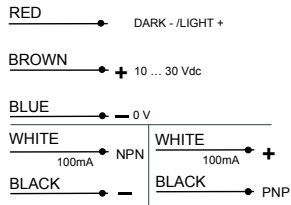

Through beam receiver - NPN/PNP version

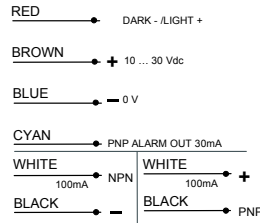

Through beam emitter - NPN/PNP version

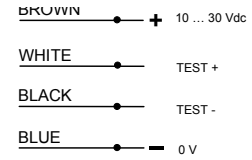

NPN or PNP and NC/NO version

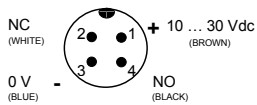

PNP version

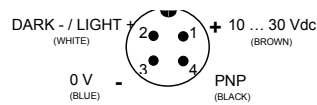

Through beam emitter - PNP version

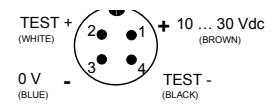

VAC MODELS

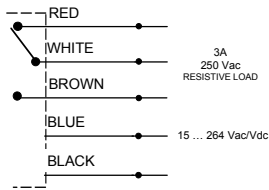

Through beam emitter

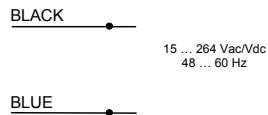

INDICATORS AND SETTINGS



Background suppression

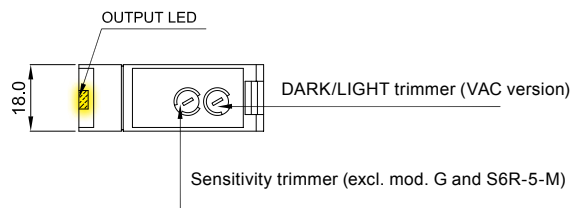
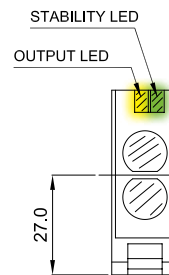
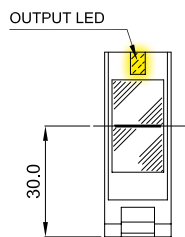

DETECTION DIAGRAMS

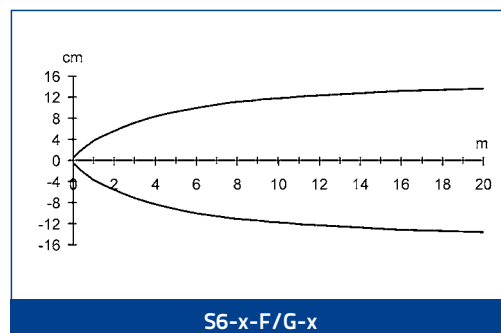
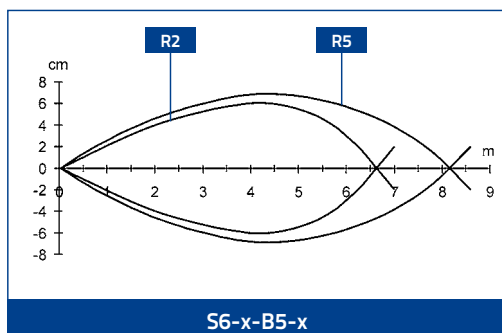
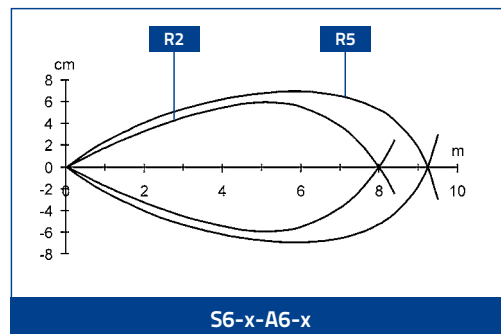
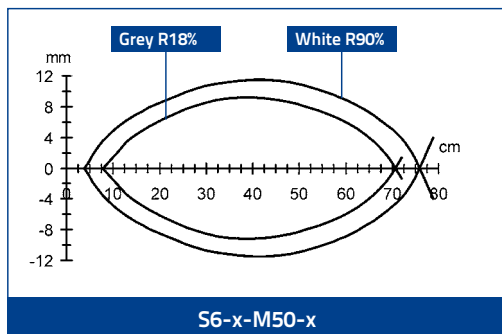
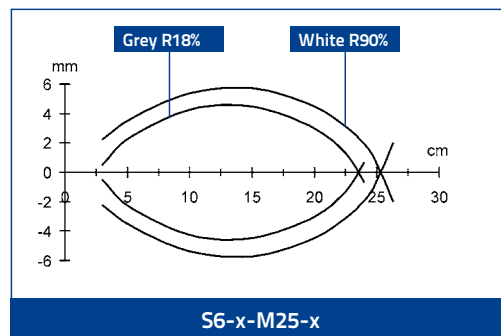
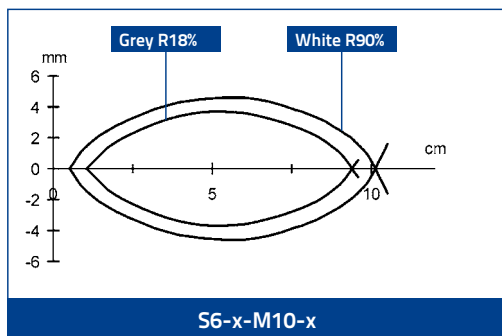
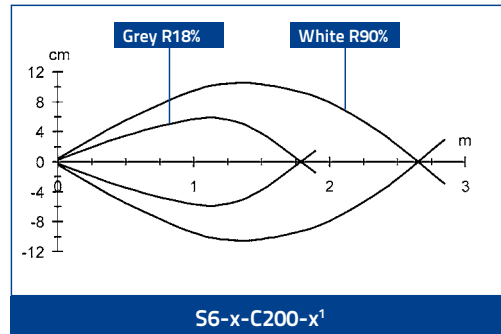
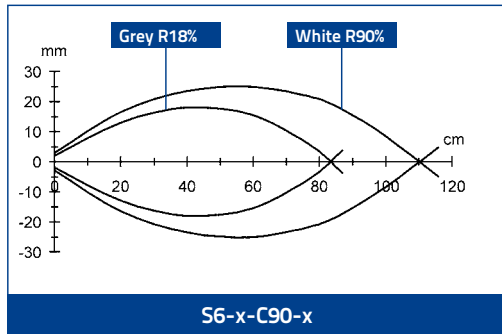

The detection diagrams indicate the typical operating distance with excess gain 1.

MODEL SELECTION AND ORDER INFORMATION

OPTIC FUNCTION	OPERATING	POWER SUPPLY	OUTPUT	MODEL	ORDER No.
Short diffuse proximity	10...900 mm	15...264 V A.C.	relay SPDT 250V/3A	S6-1-C90	S937530090
			NPN/PNP	S6-5-C90	S937530000
		10...30 V D.C.	PNP N.O./N.C.	S6R-5-C90-P	950201190
			PNP	S6T-5-C90-P	961031020
Long diffuse proximity	10...2000 mm	15...264 V A.C.	relay SPDT 250V/3A	S6-1-C200	950151140
			NPN/PNP	S6-5-C200	950201150
		10...30 V D.C.	PNP N.O./N.C.	S6R-5-C200-P	950201200
			NPN N.O./N.C.	S6R-5-C200-N	956101050
Retroreflective	0,1...6 m (on R2 reflector)	15...264 V A.C.	relay SPDT 250V/3A	S6-1-A6	S937330090
			NPN/PNP	S6-5-A6	S937330000
		10...30 V D.C.	PNP	S6T-5-A6-P	961031000
			PNP N.O./N.C.	S6R-5-A6-P	950201170
Polarized retroreflective	0,1...5 m (on R2 reflector)	15...264 V A.C.	relay SPDT 250V/3A	S6-1-B5	S937420090
			NPN/PNP	S6-5-B5	S937420000
		10...30 V D.C.	PNP N.O./N.C.	S6R-5-B5-P	950201180
			PNP	S6T-5-B5-P	961031010
Background suppression	30...100 mm	10...30 V D.C.	PNP N.O./N.C.	S6R-5-M10-P	950201230
	30...250 mm		NPN/PNP	S6-5-M25	S937830000
			PNP N.O./N.C.	S6R-5-M25-P	950201220
			NPN N.O./N.C.	S6R-5-M25-N	956101080
			PNP	S6T-5-M25-P	961041000
	100...500 mm		PNP N.O./N.C.	S6R-5-M50-P	950201250
Through beam (Receiver)	0...20 m	15...264 V A.C.	relay SPDT 250V/3A	S6-1-F20	S937200090
			NPN/PNP	S6-5-F20	S937200010
		10...30 V D.C.	PNP N.O./N.C.	S6R-5-F20-P	950201160
			PNP	S6T-5-F20-P	961211010
Through beam (Emitter)	-	15...264 V A.C.	-	S6-1-G20	S937130090
		10...30 V D.C.	-	S6-5-G20	S937130000
		-	-	S6T-5-G20	961211000

ACCESSORIES

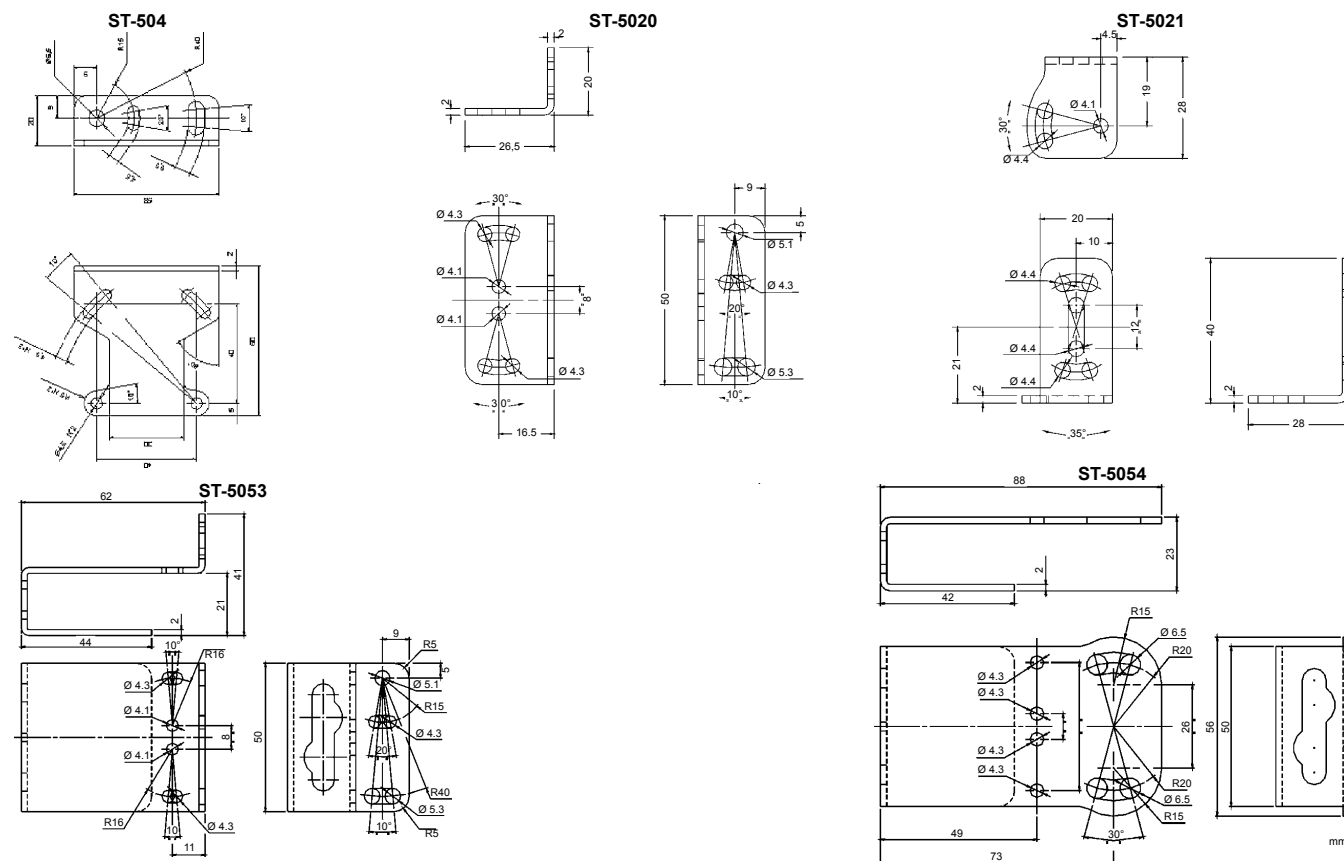

ST-5018

ST-5019

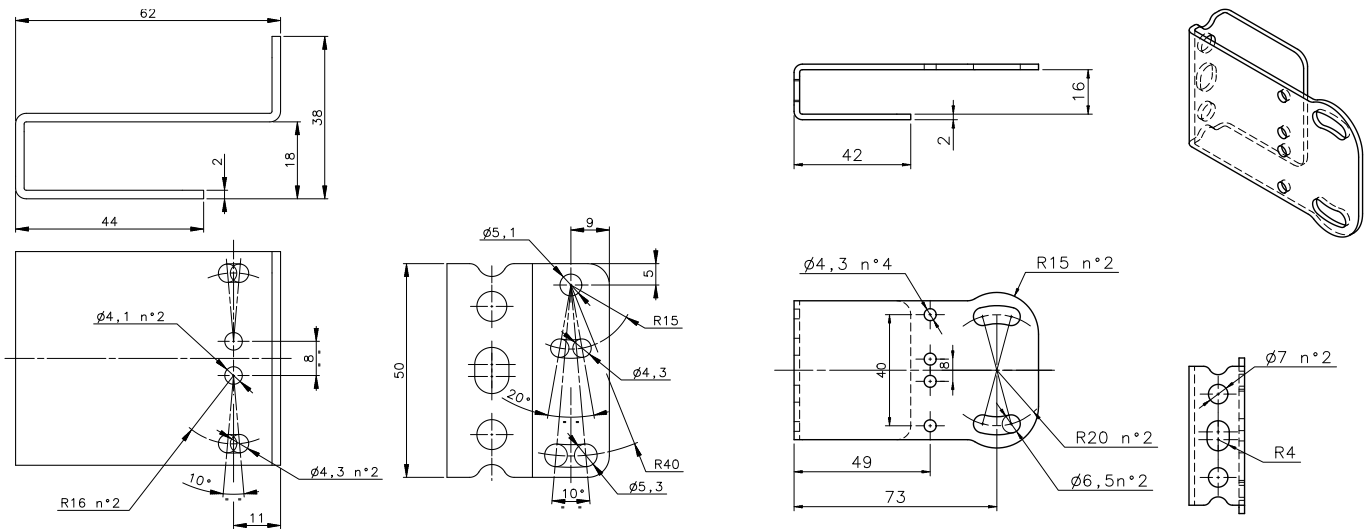

MODEL	DESCRIPTION	ORDER No.
ST-5018	protective bracket	95ACC5310
ST-5019	protective bracket	95ACC5320
ST-5020	mounting bracket	95ACC5330
ST-5021	mounting bracket	95ACC5340
ST-504	mounting bracket	95ACC2820
ST-5053	protective bracket	95ACC2410
ST-5054	protective bracket	95ACC2420
JOINT-S62	protective bracket with jointed support	95ACC2430

CABLES

TYPE	DESCRIPTION	LENGTH	MODEL	ORDER No.
Axial M12 Connector	4-pole, grey, P.V.C.	3 m	CS-A1-02-G-03	95A251380
		5 m	CS-A1-02-G-05	95A251270
		7 m	CS-A1-02-G-07	95A251280
		10 m	CS-A1-02-G-10	95A251390
	4-pole, P.U.R.	2 m	CS-A1-02-R-02	95A251540
		5 m	CS-A1-02-R-05	95A251560
Radial M12 Connector	4-pole, grey, P.V.C.	3 m	CS-A2-02-G-03	95A251360
		5 m	CS-A2-02-G-05	95A251240
		7 m	CS-A2-02-G-07	95A251245
		10 m	CS-A2-02-G-10	95A251260
	4-pole, P.U.R.	2 m	CS-A2-02-R-02	95A251550
		5 m	CS-A2-02-R-05	95A251570
Radial M12 Connector with LED (for PNP N.O. sensors)	4-pole, grey, P.V.C.	3 m	CS-A2-12-G-03	95A251400
		5 m	CS-A2-12-G-05	95A251350
		10 m	CS-A2-12-G-10	95A251370
Axial M12 Connector	4-pole, shielded, black, P.V.C.	3 m	CV-A1-22-B-03	95ACC1480
		5 m	CV-A1-22-B-05	95ACC1490
		10 m	CV-A1-22-B-10	95ACC1500
		15 m	CV-A1-22-B-15	95ACC2070
		25 m	CV-A1-22-B-25	95ACC2090
Radial M12 Connector	4-pole, shielded, black, P.V.C.	3 m	CV-A2-22-B-03	95ACC1540
		5 m	CV-A2-22-B-05	95ACC1550
		10 m	CV-A2-22-B-10	95ACC1560
Axial M12 Connector	4-pole, U.L., black, P.V.C.	3 m	CS-A1-02-U-03	95ASE1120
		5 m	CS-A1-02-U-05	95ASE1130
		10 m	CS-A1-02-U-10	95ASE1140
		15 m	CS-A1-02-U-15	95ASE1150
		25 m	CS-A1-02-U-25	95ASE1160
Radial M12 Connector	4-pole, black	Connector- not cabled	CS-A1-02-B-NC	G5085002
		Connector- not cabled	CS-A2-02-B-NC	G5085003