



S100

The universal miniature photoelectric sensor

- Two threaded front mounting holes
- Two slotted rear mounting holes
- Anti-tampering sensor (no adjustment)
- Standard optic functions
- Transparent object detection
- M8 connector and cable models
- PNP or NPN models with LIGHT/DARK selection by wire
- Plastic housing, IP67 mechanical protection



SENSORS

APPLICATIONS

- Processing and packaging machines
- Conveyors
- Automatic warehousing
- Intralogistic lines
- Bottling
- Cosmetic and Pharma machinery



S100		
Through beam		12 m
Retroreflective		7 m
Polarized Retroreflective (long range)		5,5 m
Polarized Retroreflective (short range)		3 m
Transparent Retroreflective (short range)		500 mm
Transparent Retroreflective (long range)		2 m
Diffused proximity (short range)		300 mm
Diffused proximity (long range)		500 mm
Fixed focus		70 mm
Background Suppression (short range)		100 mm
Background Suppression (long range)		200 mm
Power supply	Vdc	10...30 Vdc
Output	PNP	▪
	NPN	▪
Connection	cable	2 m cable, 4 wires
	connector	M8 conn., 4-pole
Approximate dimensions (mm)		32x20x12
Housing material		Plastic
Mechanical protection		IP67

CONNECTIONS

M8 CONNECTOR

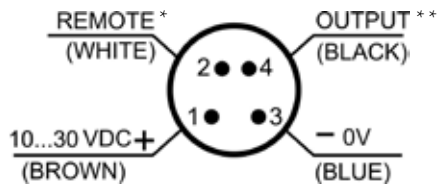

CABLE

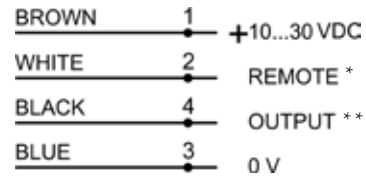

*REMOTE: Light/Dark selection (S100-...-A-B-C-D-F), External Teach-in (S100-...-Mxx/Txx)
 **OUTPUT: PNP or NPN depends on the model

INDICATORS AND SETTINGS

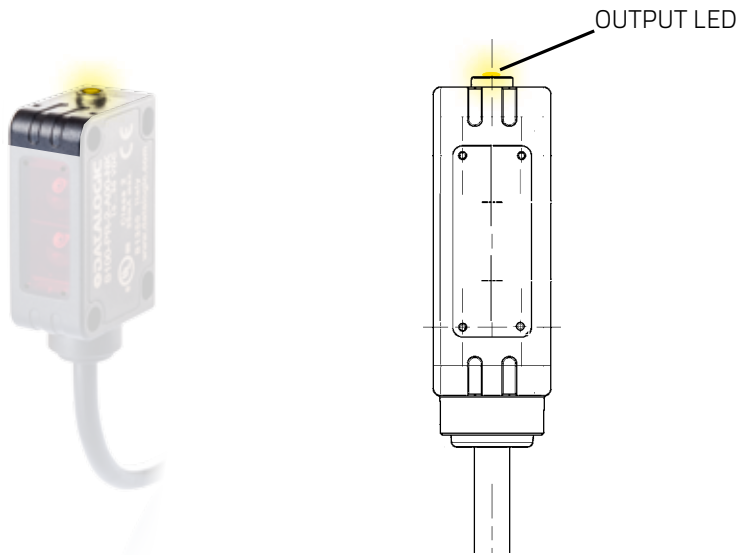

DETECTION DIAGRAMS

THROUGH BEAM

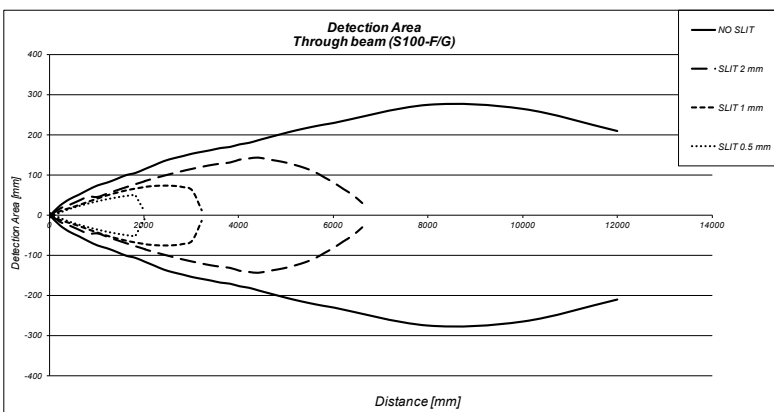

	max. operating distance
NO SLIT	12 m
2 mm SLIT	6,7 m
1 mm SLIT	3,2 m
0,5 mm SLIT	2 m

DIFFUSE PROXIMITY

	SHORT RANGE (S100-...-C0)	LONG RANGE (S100-...-C1)
Recommended operating distance (on White 90% target)	10...240 mm	2...400 mm
Maximum operating distance (White 90% target)	1...300 mm	0...500 mm
Maximum operating distance (Grey 18% target)	20...150 mm	10...280 mm
Maximum operating distance (Black 6% target)	30...80 mm	20...160 mm
Difference White-Grey	50%	50%
Difference White-Black	75%	75%
Hysteresis	20%	20%

DIFFUSE (SHORT RANGE: S100-C00)

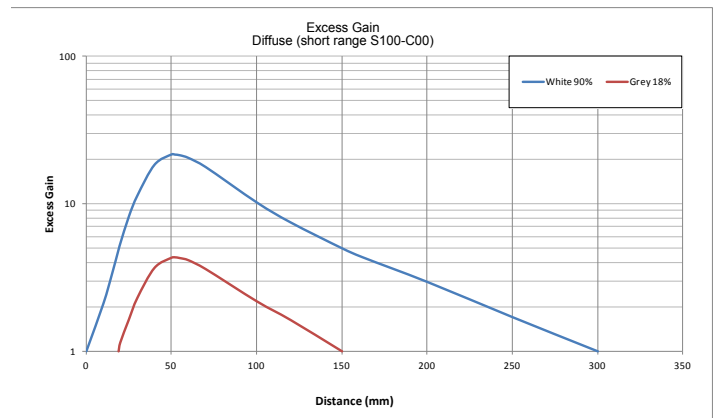
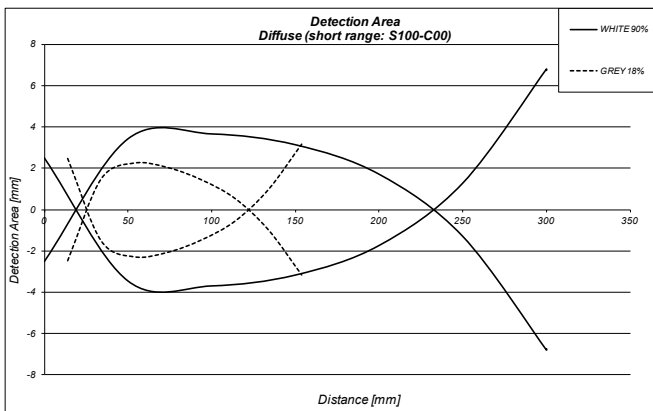

DIFFUSE (LONG RANGE: S100-C10)

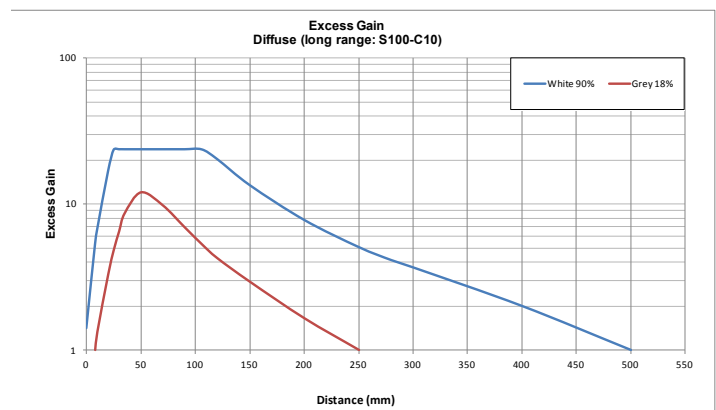
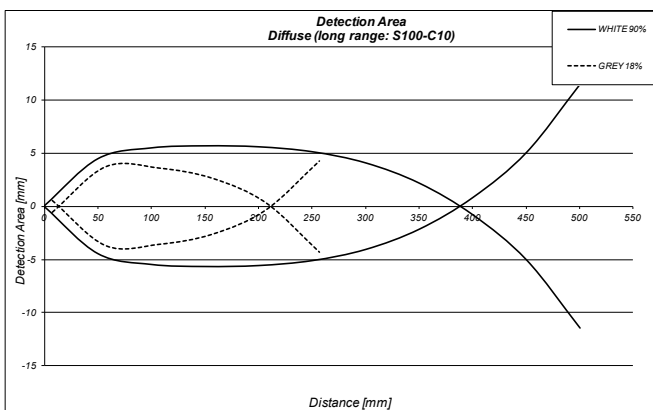

POLARIZED RETROREFLECTIVE

REFLECTOR	TYPE	SHORT RANGE (S100-...-B00)	LONG RANGE (S100-...-B10)
R1	circular (23 mm)	0,2..0,8 m	0,02..2 m
R2	circular (48 mm)	0,03..2 m	0,01..4,5 m
R3	rectangular (18x54 mm)	0,03..1,5 m	0,01..3 m
R4	rectangular (47x47 mm)	0,03..2,5 m	0,01..4,5 m
R5	circular (75 mm)	0,01..3 m	0,01..5,5 m
R6	rectangular (36x55 mm)	0,03..1,8 m	0,01..4 m
RT3970	self-adhesive tape (60x40 mm)	0,2..0,8 m	0,05..1,8 m



	max. operating distance			
	SHORT RANGE (S100-...-B00)		LONG RANGE (S100-...-B10)	
	with R5 reflector	with R2 reflector	with R5 reflector	with R2 reflector
NO SLIT	0,02 ... 3 m	0,02 ... 2 m	0,1...5,5 m	0,01...4,5 m
2 mm SLIT	0,05 ... 1,5 m	0,05 ... 0,8 m	0,2...4 m	0,03...3 m
1 mm SLIT	-	-	0,3...2,5 m	0,05...1,5 m
0,5 mm SLIT	-	-	0,5...1,2 m	0,07...0,7 m

POLARIZED RETROREFLECTIVE (SHORT RANGE: S100-B00)

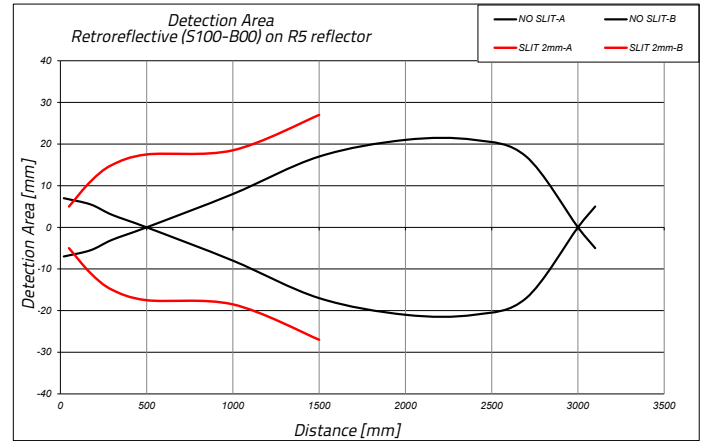
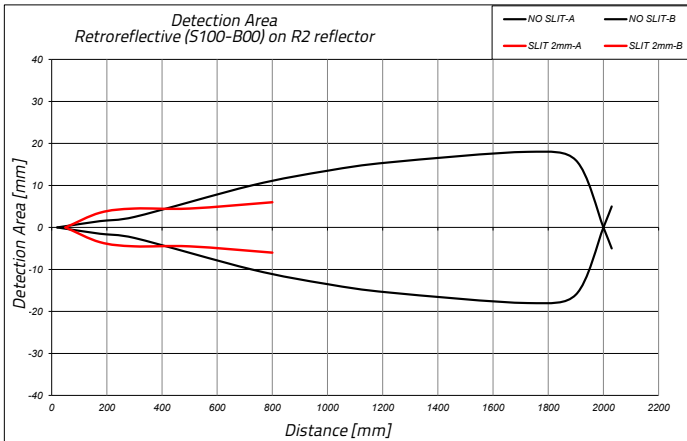

POLARIZED RETROREFLECTIVE (LONG RANGE: S100-B10)

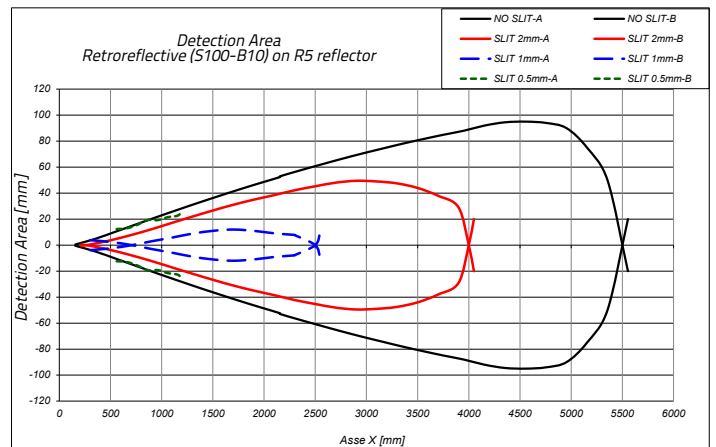
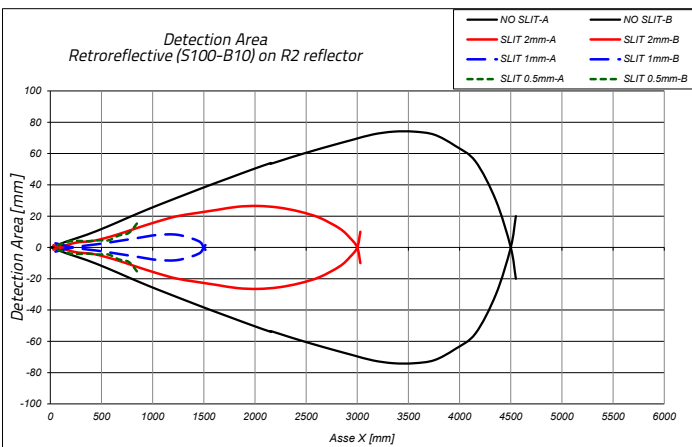

RETROREFLECTIVE (infrared)

REFLECTOR	TYPE	(S100-...-A00)
R1	circular (23 mm)	0.03..3 m
R2	circular (48 mm)	0.01..6 m
R3	rectangular (18x54 mm)	0.01..3.5 m
R4	rectangular (47x47 mm)	0.01..5 m
R5	circular (75 mm)	0.01..7 m
R6	rectangular (36x55 mm)	0.01..6 m
RT3970	self-adhesive tape (60x40 mm)	0,05..2 m



	max. operating distance	
	with R5 reflector	with R2 reflector
NO SLIT	7 m	6 m
2 mm SLIT	4,7 m	3,4 m
1 mm SLIT	2,7 m	2,3 m
0,5 mm SLIT	1,5 m	1 m

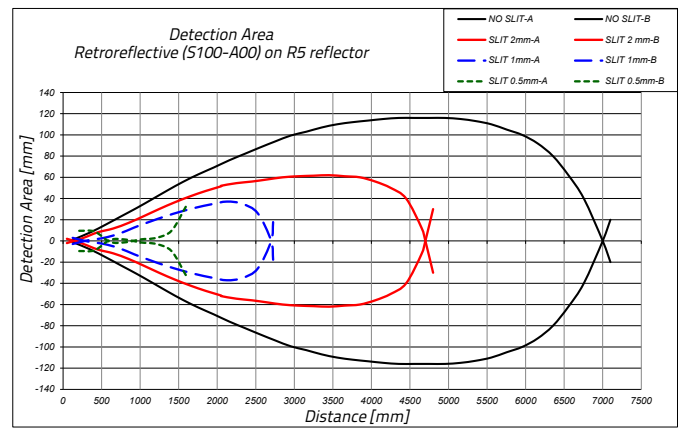
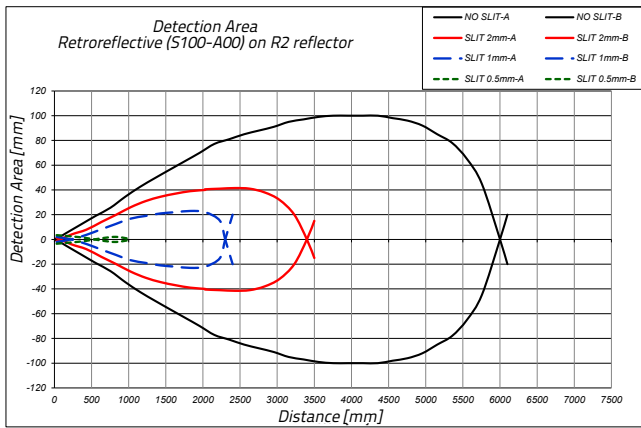

FIXED FOCUS

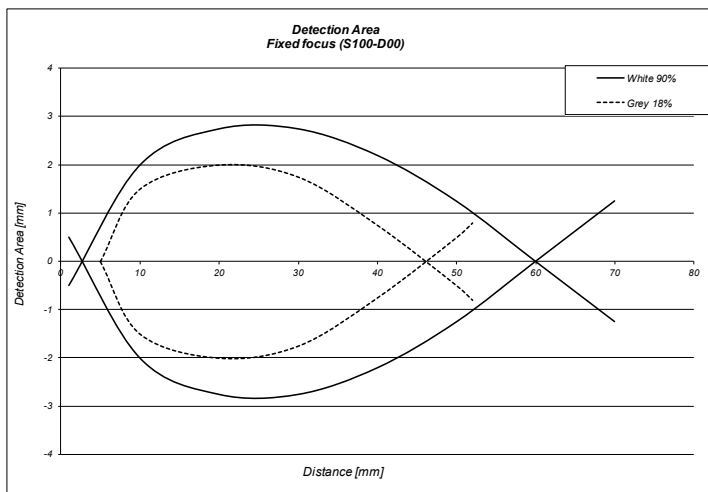

Focus point	70 mm
Maximum operating distance (White 90%)	70 mm
Maximum operating distance (Grey 18%)	55 mm
Difference White/Black	25%

RETROREFLECTIVE FOR TRANSPARENT (infrared)

REFLECTOR	TYPE	SHORT RANGE (S100-...-T00)	LONG RANGE (S100-...-T10)
R1	circular (23 mm)	0.1...0.3 m	0.4...1 m
R2	circular (48 mm)	0.1...0.5 m	0.8...2 m
R3	rectangular (18x54 mm)	0.1...0.3 m	0.4...1 m
R4	rectangular (47x47 mm)	0.1...0.5 m	0.8...2 m
R5	circular (75 mm)	0.1...0.8 m	0.8...2.5 m
R6	rectangular (36x55 mm)	0.1...0.5 m	0.8...2m
RT3970	self-adhesive tape (60x40 mm)	0.15...0.3 m	0.1...0.8 m



	max. operating distance			
	SHORT RANGE (S100-...-T00)		LONG RANGE (S100-...-T10)	
	with R5 reflector	with R2 reflector	with R5 reflector	with R2 reflector
NO SLIT	0.1...0.8 m	0.1...0.5 m	0.8...2.5 m	0.8...2 m
2 mm SLIT	0.1...0.5 m	0.1...0.3 m	0.5...1.8 m	0.5...1.6 m
1 mm SLIT	-	-	-	-
0,5 mm SLIT	-	-	-	-

TRANSPARENT RETROREFLECTIVE (SHORT RANGE: S100-T00)

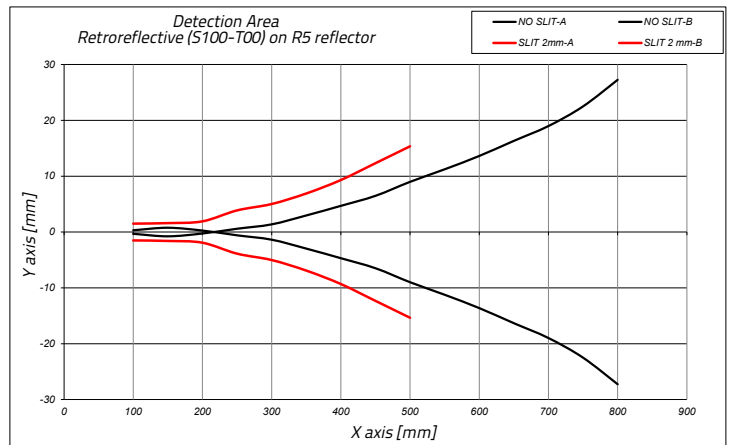
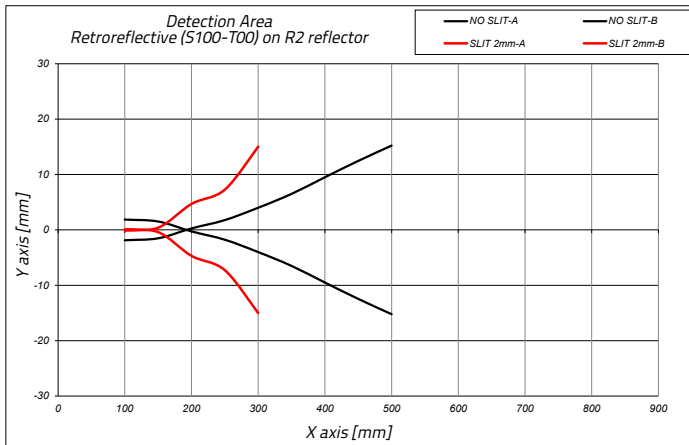

TRANSPARENT RETROREFLECTIVE (LONG RANGE: S100-T10)

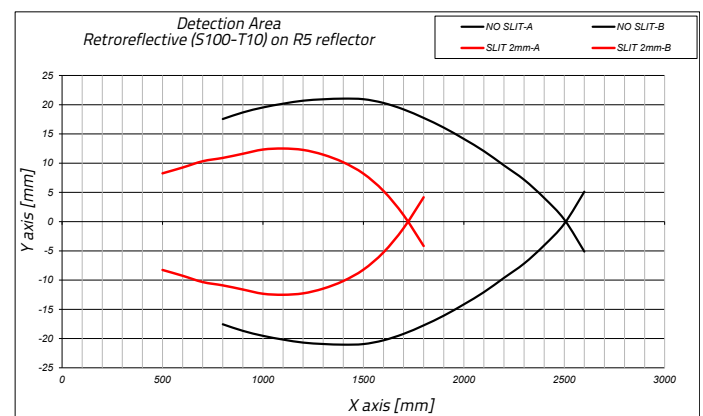
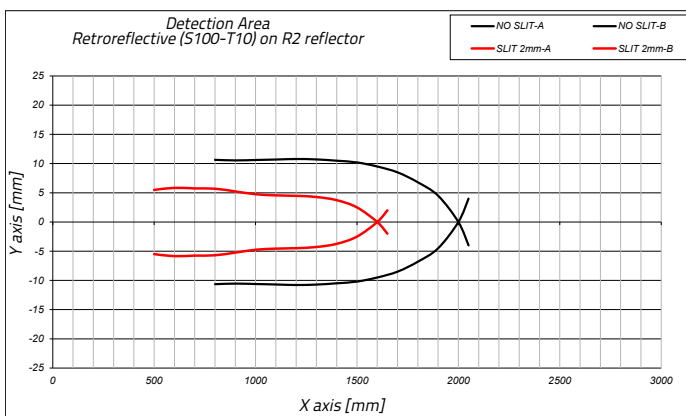

BACKGROUND SUPPRESSION

Operating distances (background suppression)	30...100 mm	30...200 mm
	S100...M00	S100...M10
Maximum operating distance (White 90%)	0...150 mm	10...250 mm
Maximum operating distance (Grey 18%)	10...110 mm	10...135 mm
Maximum operating distance (Black 6%)	10...80 mm	10...110 mm
Difference White 90%/White 90%	< 5%	< 10%
Difference White 90%/Grey 18%	< 15%	< 32%
Difference White 90%/Black 6%	< 25%	< 45%

BACKGROUND SUPPRESSION (SHORT RANGE: S100-M10)

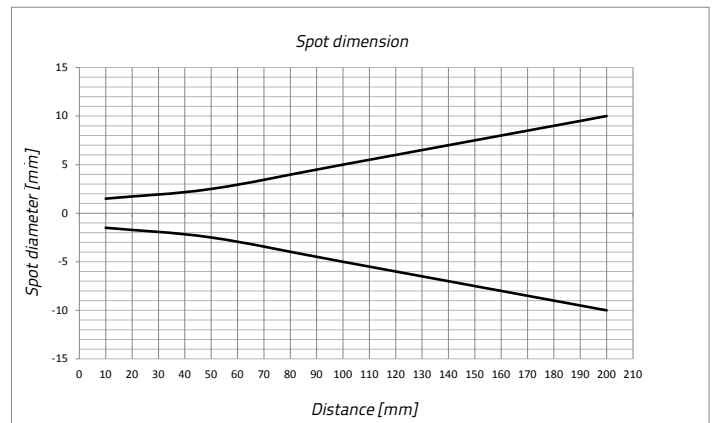
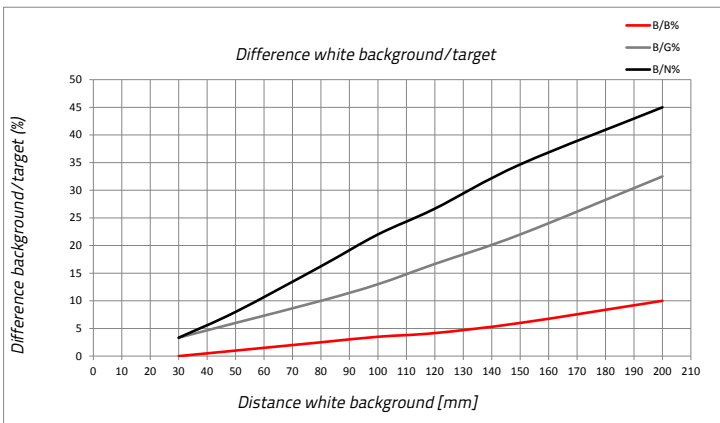

BACKGROUND SUPPRESSION (LONG RANGE: S100-M00)

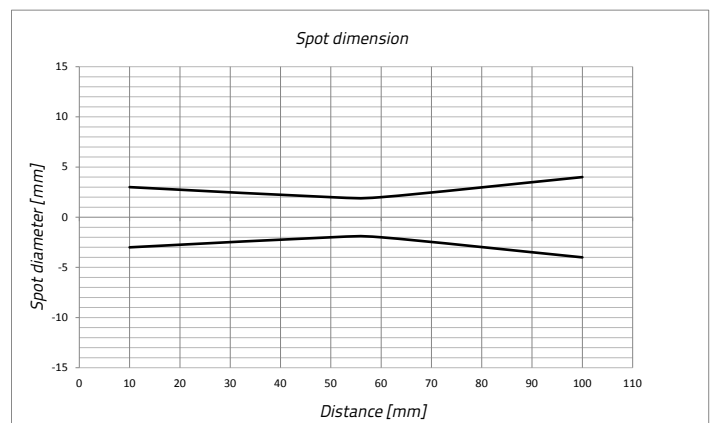
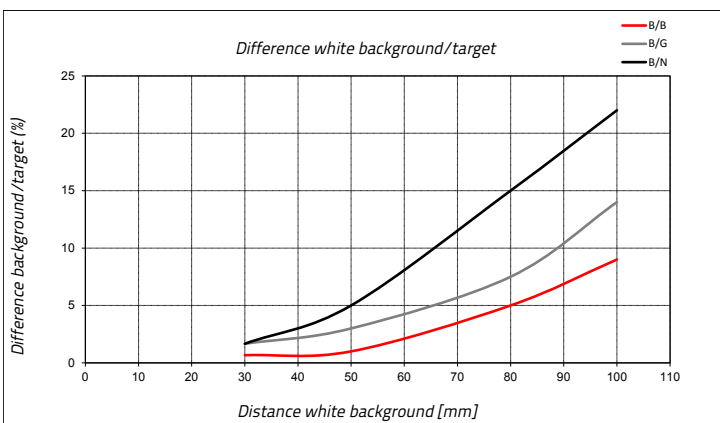

MODEL SELECTION AND ORDER INFORMATION

OPTIC FUNCTION	EMISSION	OPERATING DISTANCE	CONNECTION	OUTPUT	MODEL	ORDER No.
Through beam	IR	12 m	2 m cable	NPN	S100-PR-2-FG00-NK	950811100
				PNP	S100-PR-2-FG00-PK	950811110
			M8 connector	NPN	S100-PR-5-FG00-NK	950811240
				PNP	S100-PR-5-FG00-PK	950811250
Retroreflective	IR	7 m	2 m cable	NPN	S100-PR-2-A00-NK	950811000
				PNP	S100-PR-2-A00-PK	950811010
			M8 connector	NPN	S100-PR-5-A00-NK	950811140
				PNP	S100-PR-5-A00-PK	950811150
Polarized Retroreflective (short)	RED	2 m	2 m cable	NPN	S100-PR-2-B00-NK	950811020
				PNP	S100-PR-2-B00-PK	950811030
			M8 connector	NPN	S100-PR-5-B00-NK	950811160
				PNP	S100-PR-5-B00-PK	950811170
Polarized Retroreflective (long)	RED	5 m	2 m cable	NPN	S100-PR-2-B10-NK	950811280
				PNP	S100-PR-2-B10-PK	950811290
			M8 connector	NPN	S100-PR-5-B10-NK	950811300
				PNP	S100-PR-5-B10-PK	950811310
Transparent Retroreflective (short)	IR	500 mm	2 m cable	NPN	S100-PR-2-T00-NH	950811330
			2 m cable	PNP	S100-PR-2-T00-PH	950811320
			M8 connector	NPN	S100-PR-5-T00-NH	950811350
			M8 connector	PNP	S100-PR-5-T00-PH	950811340
Transparent Retroreflective (long)	IR	2 m	2 m cable	NPN	S100-PR-2-T10-NH	950811370
			2 m cable	PNP	S100-PR-2-T10-PH	950811360
			M8 connector	NPN	S100-PR-5-T10-NH	950811390
			M8 connector	PNP	S100-PR-5-T10-PH	950811380
Diffuse proximity (short)	RED	300 mm	2 m cable	NPN	S100-PR-2-C00-NK	950811040
				PNP	S100-PR-2-C00-PK	950811050
			M8 connector	NPN	S100-PR-5-C00-NK	950811180
				PNP	S100-PR-5-C00-PK	950811190
Diffuse proximity (long)	RED	500 mm	2 m cable	NPN	S100-PR-2-C10-NK	950811060
				PNP	S100-PR-2-C10-PK	950811070
			M8 connector	NPN	S100-PR-5-C10-NK	950811200
				PNP	S100-PR-5-C10-PK	950811210
Fixed focus	RED	70 mm	2 m cable	NPN	S100-PR-2-D00-NK	950811080
				PNP	S100-PR-2-D00-PK	950811090
			M8 connector	NPN	S100-PR-5-D00-NK	950811220
				PNP	S100-PR-5-D00-PK	950811230
Background suppression (short range)	RED	30...100 mm	2 m cable	NPN	S100-PR-2-M00-NH	950811120
				PNP	S100-PR-2-M00-PH	950811130
			M8 connector	NPN	S100-PR-5-M00-NH	950811260
				PNP	S100-PR-5-M00-PH	950811270
Background suppression (long range)	IR	30...200 mm	2 m cable	NPN	S100-PR-2-M10-NH	950811420
				PNP	S100-PR-2-M10-PH	950811430
			M8 connector	NPN	S100-PR-5-M10-NH	950811400
				PNP	S100-PR-5-M10-PH	950811410

ACCESSORIES

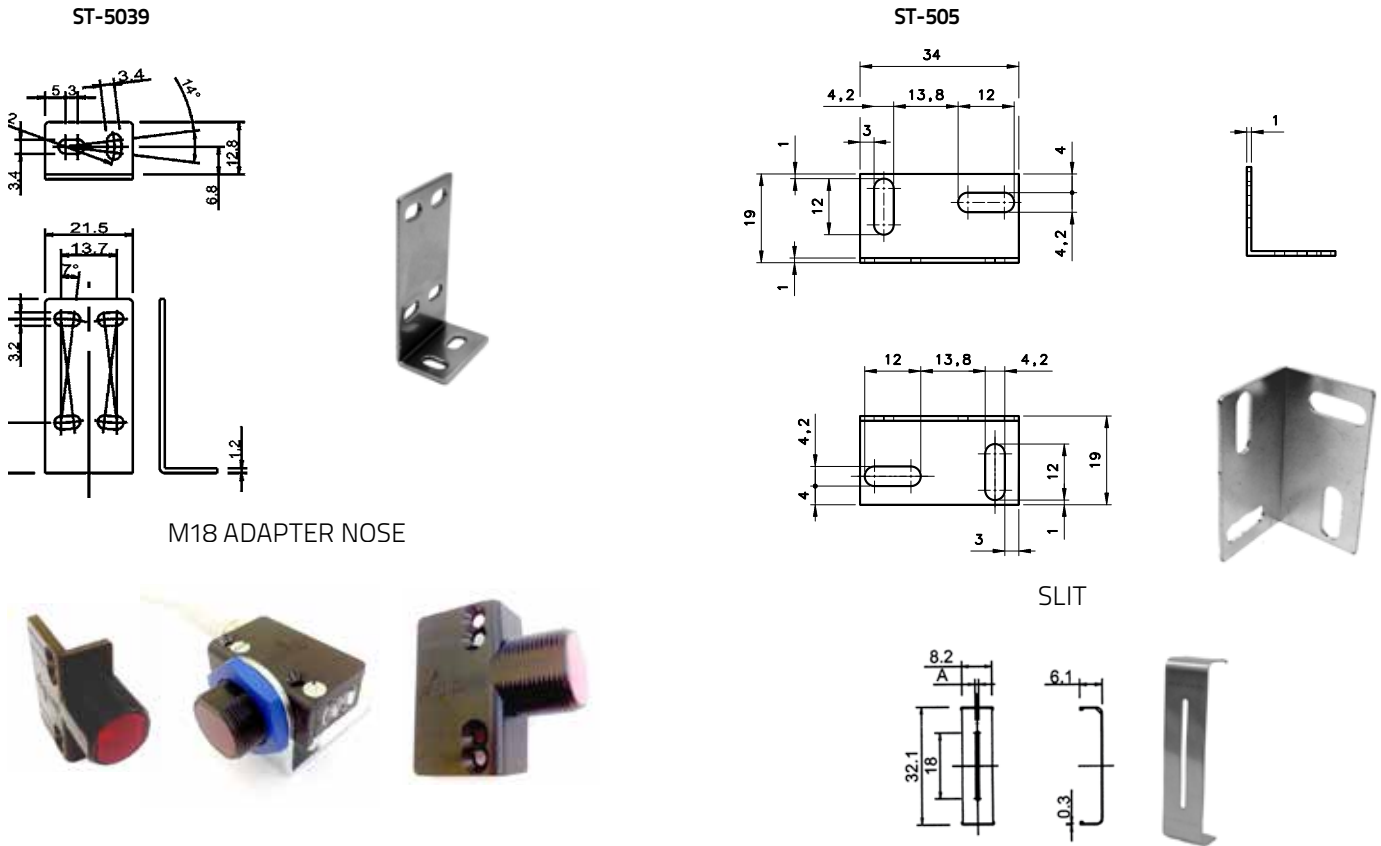

TYPE	MODEL	DESCRIPTION	Order No.
Mounting bracket	ST-505	lateral mounting	95ACC2800
	ST-5039	L-shaped bracket	95ACC2270
Slit	S100-SLIT-05	0,5x19 mm SLIT	95ACC3450
	S100-SLIT-1	1x19 mm SLIT	95ACC3460
	S100-SLIT-2	2x19 mm SLIT	95ACC3470
M18 adapter	ST-S3Z-M18	M18 THREADED ADAPTER NOSE	95ACC7850

CABLES

TYPE	DESCRIPTION	LENGTH	MODEL	ORDER No.
Axial M8 Connector	4-pole, grey, P.V.C.	3 m	CS-B1-02-G-03	95A251420
		5 m	CS-B1-02-G-05	95A251430
		7 m	CS-B1-02-G-07	95A251440
		10 m	CS-B1-02-G-10	95A251480
	4-pole, P.U.R.	2 m	CS-B1-02-R-02	95A251620
		5 m	CS-B1-02-R-05	95A251640
Radial M8 Connector	4-pole, grey, P.V.C.	3 m	CS-B2-02-G-03	95A251450
		5 m	CS-B2-02-G-05	95A251460
		7 m	CS-B2-02-G-07	95A251470
		10 m	CS-B2-02-G-10	95A251530
	4-pole, P.U.R.	2 m	CS-B2-02-R-02	95A251630
		5 m	CS-B2-02-R-05	95A251650